

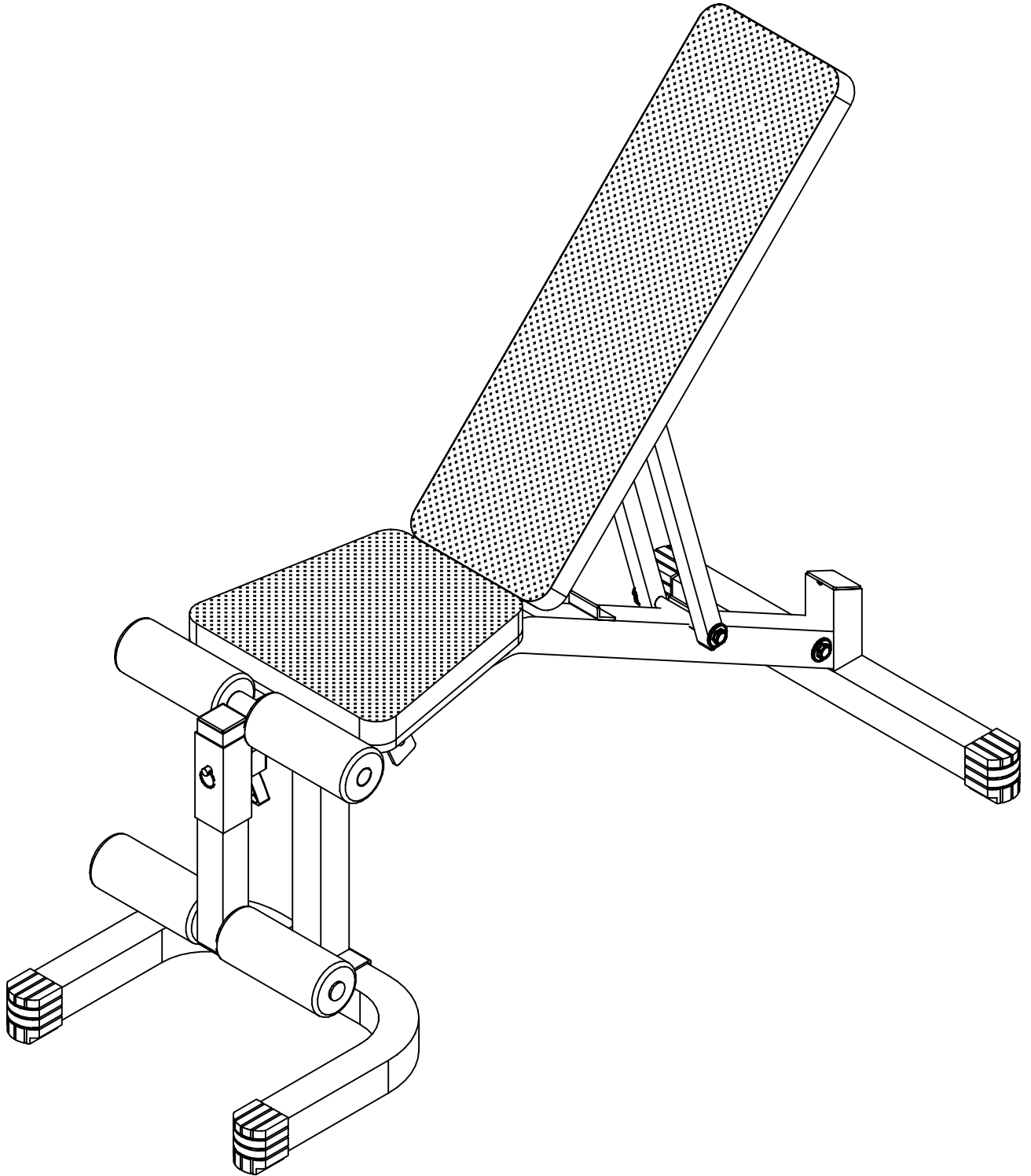









PFID-130.2











VERSION 0302

	Qty.
A1. M8X20L HEX HEAD BOLT	[6PCS]
A2. M8X45L HEX HEAD BOLT	[1PCS]
A3. M10X65L HEX HEAD BOLT	[1PCS]
A4. M10X70L HEX HEAD BOLT	[2PCS]
A5. M10X80L HEX HEAD BOLT	[2PCS]
A6. M10X145L HEX HEAD BOLT	[2PCS]
B1. M10 NYLON LOCK NUT	[7PCS]
C1. M8 SPRING WASHER	[7PCS]
C2. M8 (I.D)WASHER	[7PCS]
C3. M10 (I.D)WASHER	[14PCS]

	Qty.
D1. QUICK RELEASE RING PIN (8250-015)	[1PCS]
D2. QUICK RELEASE BALL PIN (8250-016)	[1PCS]
D3. 1"X1" END CAP (9211-001)	[4PCS]
D4. 45X45 END CAP (9211-004)	[2PCS]
D5. 2"X2" END CAP (9211-005)	[1PCS]
D6. 1"X2" END CAP (9211-009)	[1PCS]
D7. ROUND END CAP (9211-016)	[4PCS]
D8. 2"X2" FOOT CAP (9212-003)	[4PCS]

A1	A2	A3	A4	A5	A6
					
B1	C1	C2	C3		
					

D1	D2	D3	D4
			
D5	D6	D7	D8
			

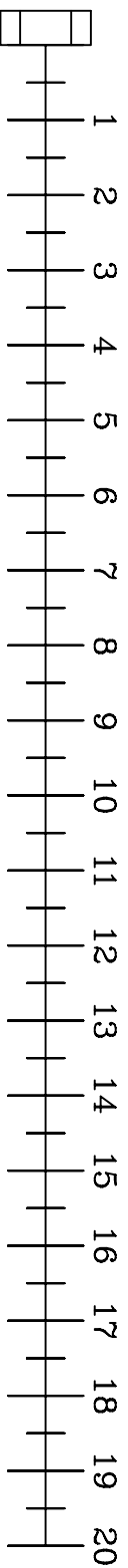

A [1PCS]

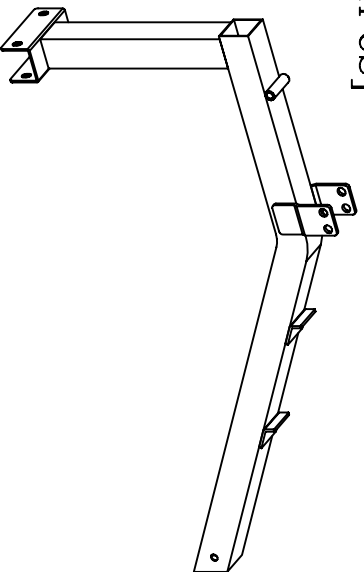

F [1PCS]

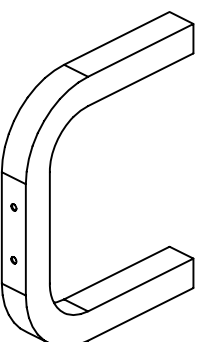

G [2PCS]

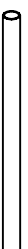

H [1PCS]



B [1PCS]

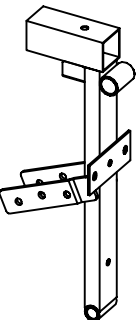

I [1PCS]

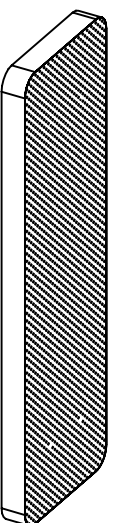

J [1PCS]

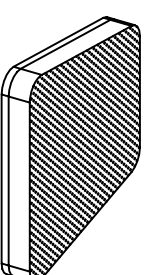

C [1PCS]

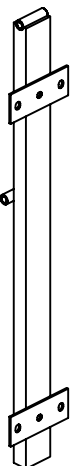

K [4PCS]



L [1PCS]



D [1PCS]

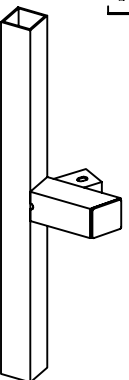

E [2PCS]



# PFID-130.2

